

KEY FEATURES

- Switching Power Module for PCB Mountable
- Universal Input: 90-264 VAC
- Single Output
- 5 VDC to 48 VDC Output
- -40°C Starting
- Screw Terminal For Optional
- 4000 VAC Input to Output Isolation
- CE, UL, Approval
- 3-Year Product Warranty



ELECTRICAL SPECIFICATIONS

All specifications valid at normal input voltage, full load and +25°C after warm-up time unless otherwise stated.

Model No.	AEC60-5S	AEC60-9S	AEC60-12S	AEC60-15S	AEC60-24S	AEC60-48S
Max Output Wattage (W)	50W	60W	60W	60W	60W	60W
Input	Voltage					
	90-264 VAC or 120-370 VDC					
	Frequency (Hz)					
	47-63 Hz					
	Current (Full load)					
2 A max. (115 VAC) / 1 A max. (230 VAC)						
Inrush Current (<2ms)						
30 A max. (115 VAC) / 50 A max. (230 VAC)						
Leakage Current						
0.5 mA max.						
Output	Voltage (V.DC.)					
	5V	9V	12V	15V	24V	48V
	Voltage Accuracy					
	±2%					
	Current (mA) max					
	10,000	6,660	5,000	4,000	2,500	1,250
	Line Regulation (LL-HL) (typ.)					
	±1%					
	Load Regulation (5-100%) (typ.)					
	±1%					
	Minimum Load					
	1%					
Maximum Capacitive Load (at 230VAC)						
80000 uF	28000 uF	14000 uF	12000 uF	4000 uF	950 uF	
Ripple						
<0.2% Vout +40mV max (Vp-p)						
Noise						
<0.5% Vout +50mV max (Vp-p)						
Efficiency (at 230V)						
82%	84%	86%	86%	86%	86%	
Trim						
±10%						
Hold-up Time						
10 ms min.						
Protection	Over Power Protection					
	Auto recovery					
	Over Voltage Protection					
Zener diode clamp						
Short Circuit Protection						
Auto recovery						
Isolation	Input-Output (V.AC)					
	4000V					
	Input-FG (V.AC)					
1500V						
Output-FG (V.AC)						
500V						
Environment	Operating Temperature					
	-40°C...+70°C (with derating)					
	Storage Temperature					
	-50°C...+85°C					
	Temperature coefficient					
±0.02%/°C						
Humidity						
95% RH						
MTBF						
>300,000 h @ 25°C (MIL-HDBK-217F)						
Physical	Dimension (L x W x H)					
	4.3 x 2.3 x 1.18 Inches (109.0 x 58.5 x 30.0 mm) Tolerance ±0.1 mm					
	Case Material					
	Plastic resin (flammability to UL 94V-0)					
Weight						
310 g						
Cooling Method						
Free air convection						
Safety	Agency Approvals					
CE, UL60950						
EMC	EMI (Conducted & Radiated Emission)					
	EN 55022 class B					
EMS (Noise Immunity)						
EN 55024						

NOTE

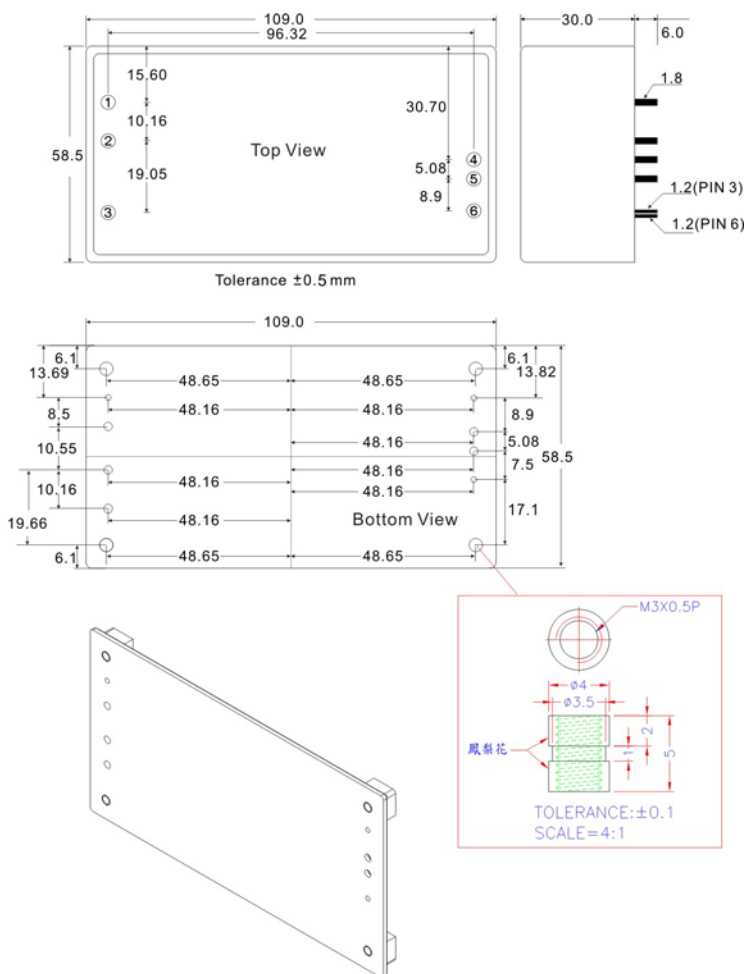
1. Ripple & Noise are measured at 20MHz of bandwidth with 0.1uF & 47uF parallel capacitor.
2. It's recommended to add Varistor 14S471K at L / N input side in parallel.
3. Please refer to our PDF file "AC-DC Application" on our website: www.archcorp.com.tw

MECHANICAL DIMENSION (Top View)

PIN#	Single
1	AC IN (N)
2	AC IN (L)
3	FG
4	+DC OUT
5	-DC OUT
6	Trim

DERATING

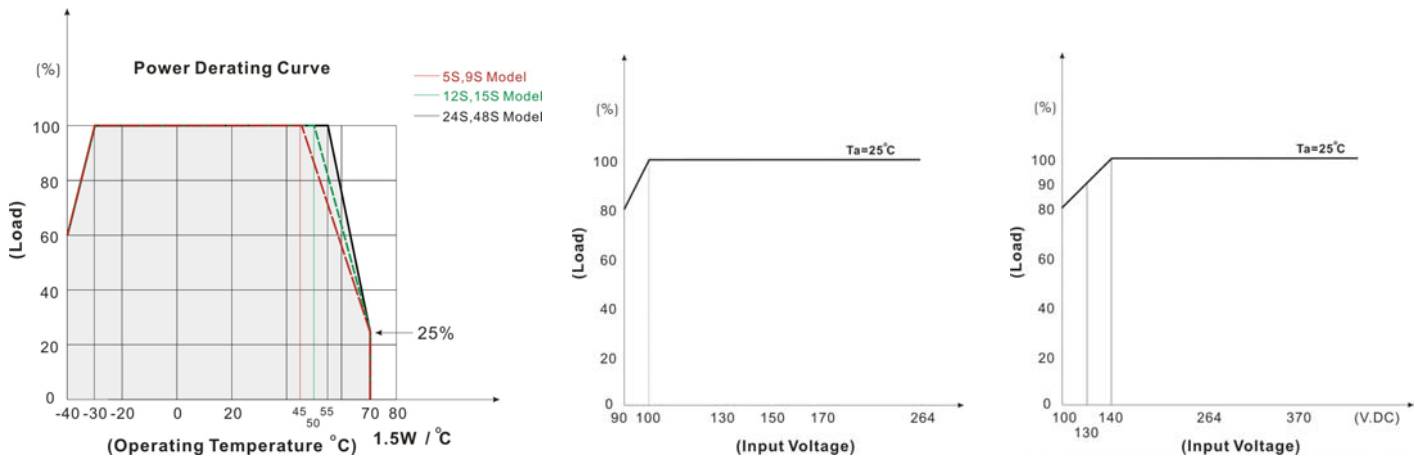

BLOCK DIAGRAM

	5S		9S		12S		15S		24S		48S	
Trim → -V	+10%	0%	+10%	0%	+10%	0%	+10%	0%	+10%	0%	+10%	0%
	500Ω	~ 1M	6KΩ	~ 1M	4KΩ	~ 1M	5KΩ	~ 1M	12KΩ	~ 1M	12KΩ	~ 1M
Trim → +V	0%	-10%	0%	-10%	0%	-10%	0%	-10%	0%	-10%	0%	-10%
	1M	~ 500Ω	1M	~ 20KΩ	1M	~ 40KΩ	1M	~ 60KΩ	1M	~ 110KΩ	10M	~ 290KΩ

Single Output

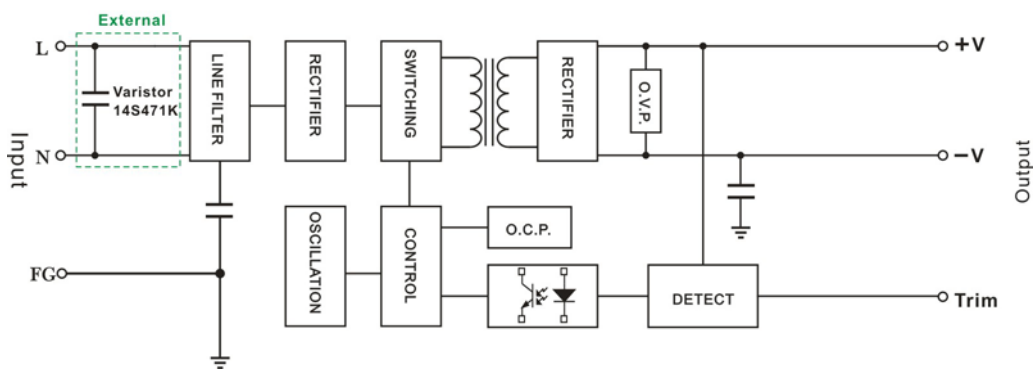

SCREW TERMINAL
AEC60-A2

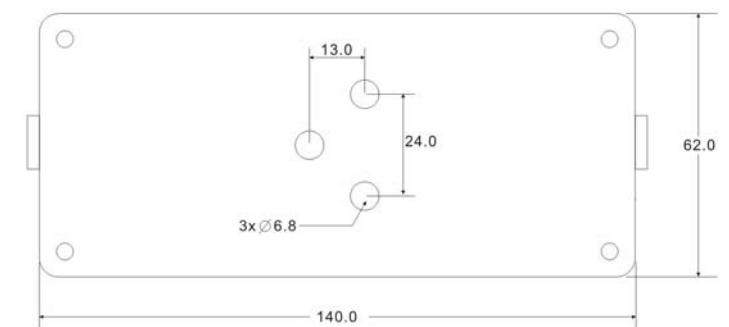
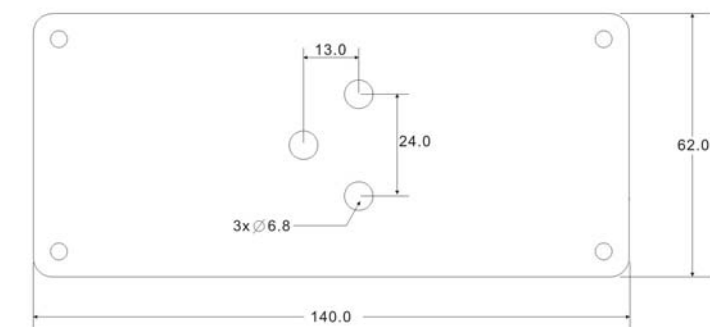
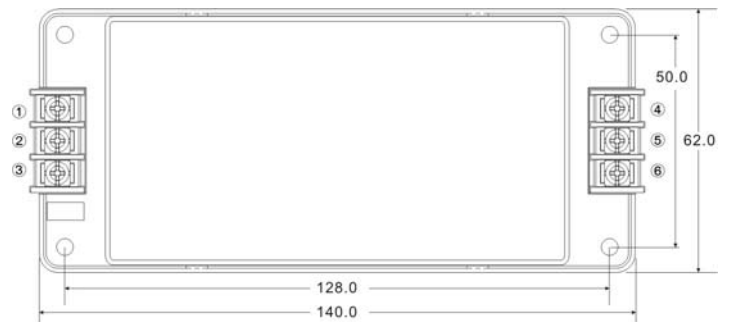
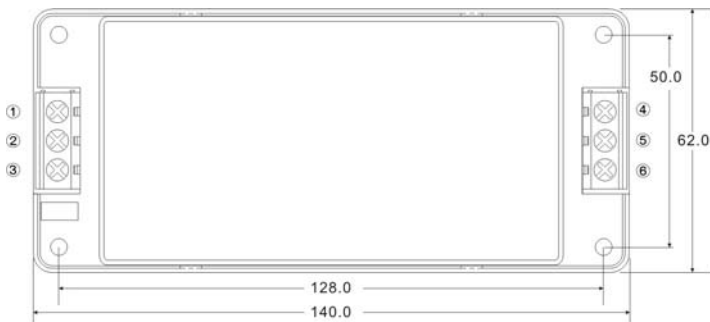
AEC60-A5

PIN#	Single
1	FG
2	AC IN (N)
3.	AC IN (L)
4	+DC OUT
5	-DC OUT
6	Trim

PIN#	Single
1	FG
2	AC IN (N)
3.	AC IN (L)
4	+DC OUT
5	-DC OUT
6	Trim