

KEY FEATURES

- Switching Power Module for PCB Mountable
- Fully Encapsulated Plastic Case
- Universal Input Range 90-305VAC, 47-440 Hz
- Single and Dual Output
- Regulated Output and Low Ripple and Low Noise
- Isolation Class II
- Maximum No-Load Watts < 0.3W
- Small Size as AHC 5Watt with 8Watt Higher Power
- CE, UL Approval
- 3-Year Product Warranty

ELECTRICAL SPECIFICATIONS

All specifications valid at normal input voltage, full load and +25°C after warm-up time unless otherwise stated.

Model No. (Single Output)	AHC08 -3.3S	AHC08 -3.8S	AHC08 -5S	AHC08 -8S	AHC08 -9S	AHC08 -12S	AHC08 -14S	AHC08 -15S	AHC08 -24S											
Max Output Wattage (W)	6.6W	8W	8W	8W	8W	8W	8W	8W	8W											
Input	Voltage										90-305 VAC or 120-430 VDC									
	Frequency (Hz)										47-440 Hz									
	Current (Full load)										180 mA max. (115 VAC) / 110 mA max. (230 VAC)									
	Inrush Current (<500us)										25 A max. (115 VAC) / 45 A max. (230 VAC)									
	Leakage Current										0.25 mA max.									
	External Fuse (recommend)										2 A slow blow type									
Output	Voltage (V.DC.)		3.3V	3.8V	5V	8V	9V	12V	14V	15V	24V									
	Voltage Accuracy										±2%									
	Current (mA) max		2000	2100	1600	1000	888	666	571	533	335									
	Line Regulation (LL-HL) (typ.)										±0.2%									
	Load Regulation (balanced)					±1%.					±0.5%.									
	Minimum Load										0%									
	Maximum Capacitive Load (at 230VAC)		26000uF	25000uF	6000uF	2500uF	2300uF	1050uF	500uF	440uF	180uF									
	Ripple					3.3S~15S : <100mV max (Vp-p)					24S : <150mV max (Vp-p)									
	Noise					3.3S~15S : <150mV max (Vp-p)					24S : <200mV max (Vp-p)									
	Efficiency		69%	71%	72%	79%	79%	79%	80%	80%	81%									
Hold-up Time										10 ms min.										
Protection	Over Power Protection										Hiccup technique, auto-recovery									
	Over Voltage Protection										Zener diode clamp									
	Short Circuit Protection										Hiccup mode, indefinite (automatic recovery)									
Isolation	Input-Output (V.AC)										3000V									
Environment	Operating Temperature										-40°C...+70°C (with derating)									
	Storage Temperature										-40°C...+85°C									
	Temperature Coefficient										±0.02%/°C									
	Humidity										95% RH									
	MTBF										>450,000 h @ 25°C (MIL-HDBK-217F)									
Physical	Dimension (L x W x H)										2.055 x 1.055 x 0.75 Inches (52.2 x 26.8 x 19.0 mm) Tolerance ±0.5 mm									
	Case Material										Plastic resin (flammability to UL 94V-0)									
	Weight										35 g									
	Cooling Method										Free air convection									
Safety	Agency Approvals										CE, UL, cUL									
EMC	EMI (Conducted & Radiated Emission)										EN 55022 class B									
	EMS (Noise Immunity)										EN 55024									

ELECTRICAL SPECIFICATIONS

All specifications valid at normal input voltage, full load and +25°C after warm-up time unless otherwise stated.

Model No. (Dual Output)	AHC08-5S3.3S	AHC08-8S5S	AHC08-12S5S	AHC08-12S7.5S			
Max Output Wattage (W)	9W	8.75W	9W	8.6W			
Input	Voltage						
	90-305 VAC or 120-430 VDC						
	Frequency (Hz)						
	47-440 Hz						
	Current (Full load)						
	200 mA max. (115 VAC) / 125 mA max. (230 VAC)						
Inrush Current (<500us)							
25 A max. (115 VAC) / 45 A max. (230 VAC)							
Leakage Current							
0.25 mA max.							
External Fuse (recommend)							
2 A slow blow type							
Output	Voltage (V.DC.)		Vo : 5V Vr : 3.3V	Vo : 8V Vr : 5V	Vo : 12V Vr : 5V	Vo : 12V Vr : 7.5V	
	Voltage Accuracy		Vo : ±2% Vr : ±15%	Vo : ±2% Vr : ±5%			
	Current (mA) max		1600 / 310	1000 / 150	666 / 200	560 / 250	
	Line Regulation (LL-HL) (typ.)		Vo : ±0.2% Vr : ±3%				
	Load Regulation (balanced)		Vo : ±0.5% Vr : ±5%				
	Minimum Load		25%				
	Maximum Capacitive Load (at 230VAC)		Vo : 1200uF Vr : 1000uF	Vo : 800uF Vr : 3800uF	Vo : 260 uF Vr : 3800uF	Vo : 260 uF Vr : 4000uF	
	Ripple		<100mV max (Vp-p)				
	Noise		<150mV max (Vp-p)				
	Efficiency		71%	77%	78%	78%	
	Hold-up Time		10 ms min.				
	Protection	Over Power Protection		Hiccup technique, auto-recovery			
Over Voltage Protection		Zener diode clamp					
Short Circuit Protection		Hiccup mode, indefinite (automatic recovery)					
Isolation	Input-Output (V.AC)		3000V				
Environment	Operating Temperature		-40°C...+70°C (with derating)				
	Storage Temperature		-40°C...+85°C				
	Temperature Coefficient		±0.02%/°C				
	Humidity		95% RH				
	MTBF		>450,000 h @ 25°C (MIL-HDBK-217F)				
Physical	Dimension (L x W x H)		2.055 x 1.055 x 0.75 Inches (52.2 x 26.8 x 19.0 mm) Tolerance ±0.5 mm				
	Case Material		Plastic resin (flammability to UL 94V-0)				
	Weight		35 g				
	Cooling Method		Free air convection				
Safety	Agency Approvals		CE, UL, cUL				
EMC	EMI (Conducted & Radiated Emission)		EN 55022 class B				
	EMS (Noise Immunity)		EN 55024				

NOTE

- Ripple & Noise are measured at 20MHz of bandwidth with 0.1uF & 47uF parallel capacitor.
- Cross Regulation for dual output:
 - If $I_o=100\% \sim 80\%$ & $I_r=100\% \sim 80\%$ then Corss Regulation $\leq \pm 10\%$
 - If $I_o=100\% \sim 25\%$ & $I_r=100\% \sim 25\%$ then Corss Regulation $\leq \pm 18\%$
- It's necessary Varistor 14S561K at L / N input side in parallel.
- It's necessary 10R / 15φ thermistor at L input side in series connection.
- Please refer to our PDF file "AC-DC Application" on our website: www.archcorp.com.tw

OUTPUT NOISE

The output noise is measured with 47 μ F tantalum capacitor and 0.1 μ F ceramic capacitor across output.

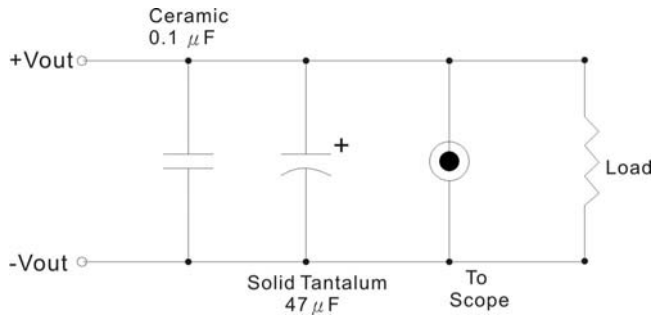

MECHANICAL DIMENSION (Top View)

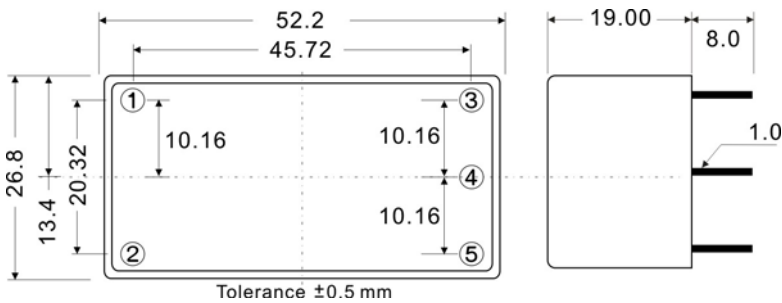

PIN#	Single	Dual
1	AC IN (N)	AC IN (N)
2	AC IN (L)	AC IN (L)
3	+DC OUT	+DC OUT
4	-DC OUT	-DC OUT
5	NO PIN	VR

BLOCK DIAGRAM

Single Output

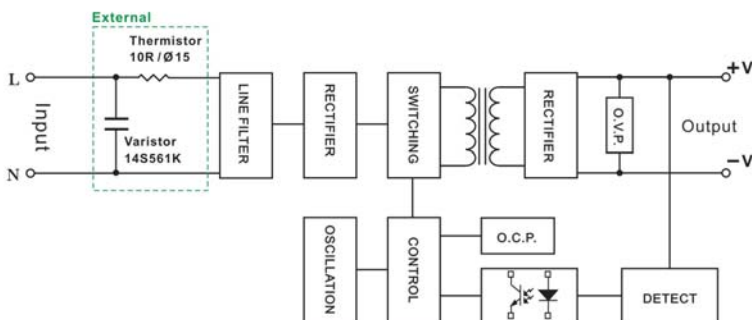

Dual Output

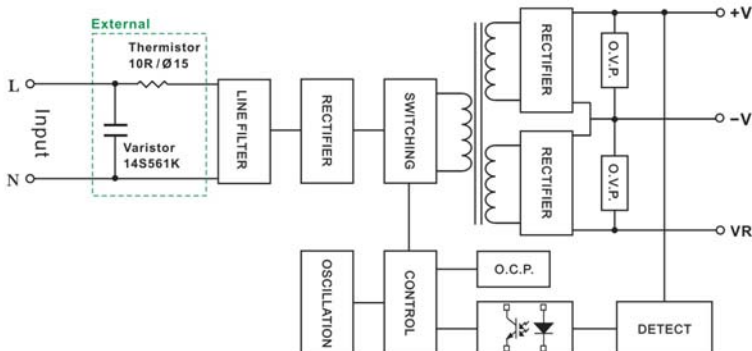

DERATING

