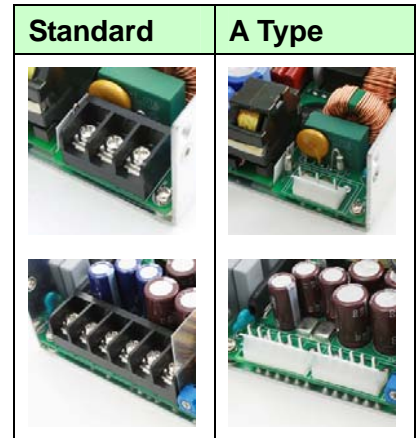

KEY FEATURES

- U Bracket Switching Power Supply
- Universal Input: 90-264 VAC
- Active P.F.C. Function, PF>0.95
- 300W Convection without FAN
- 480W Convection with 18CFM FAN
- Protections: Over Load / Over Voltage /
Over Temperature / Short Circuit
All by Auto-recovery
- Built-in Remote ON/OFF Control
- Stand by 5V @ 0.3A
- Stand by 5V @ 0.6A with 18CFM FAN
- High Efficiency up to 92%
- Ultra Compact Size: 7.0 x 4.2 x 1.78 Inches
- 3-Year Product Warranty

ELECTRICAL SPECIFICATIONS

All specifications valid at normal input voltage, full load and +25°C after warm-up time unless otherwise stated.

Model No.	AQFC480U-12S	AQFC480U-24S	AQFC480U-36S	AQFC480U-48S		
Max Output Wattage (Convection) (W)	280W	280W	300W	300W		
Max Output Wattage (18CFM FAN) (W)	480W					
Input	Voltage					
	90-264 VAC or 120-370 VDC					
	Frequency (Hz)					
	47-63 Hz					
	Current (Full load)					
	< 5.5 A max. (115 VAC) / < 3.0 A max. (230 VAC)					
Inrush Current (<2ms)						
< 50 A max. (115 VAC) / < 70 A max. (230 VAC)						
Leakage Current						
< 0.5 mA max.(240VAC 63Hz)						
Power Factor						
PF>0.95 (115 VAC) / PF>0.90 (230 VAC) at Full Load						
Output	Constant Current Range (V.DC)		10 ~ 13.2V	20 ~ 26.4V	26 ~ 36V	30 ~ 50.4V
	Current Adj. Range (Convection) (A) max		5 ~ 23.33	4 ~ 11.66	3 ~ 8.33	3 ~ 6.25
	Current Adj. Range (18CFM FAN) (A) max		5 ~ 40	4 ~ 20	3 ~ 13.33	3 ~ 10
	Minimum Load		5%			
	Maximum Capacitive Load		180000 uF	75000 uF	50000 uF	25000 uF
	Ripple & Noise (max.)		100mVp-p	200mVp-p	200mVp-p	300mVp-p
	Efficiency (Convection) (%)	Vin:115(V.AC)	88%	89%	90%	89%
		Vin:230(V.AC)	90%	91%	92%	91%
	Efficiency (18CFM FAN) (%)	Vin:115(V.AC)	85%	87%	89%	88%
		Vin:230(V.AC)	88%	90%	92%	91%
Hold-up Time		10 ms min.				
Protection	Over Power Protection		Auto recovery			
	Over Voltage Protection		Auto recovery			
	Over Temperature		Auto recovery			
	Short Circuit Protection		Auto-recovery			
Isolation	Input-Output (V.AC)		3000VAC or 4242VDC			
	Input-FG (V.AC)		1500V			
	Output-FG (V.AC)		500V			
Function	5V Stand by (18CFM FAN)		5VSB: 5V@0.6A ; Tolerance ±10% , Ripple & Noise: 100m Vp-p (max.)			
	Remote Control		+RC / -RC: Power ON=open ; Power OFF=short			
	FAN Control		12VDC / 0.5A max.			

ELECTRICAL SPECIFICATIONS

All specifications valid at normal input voltage, full load and +25°C after warm-up time unless otherwise stated.

Model No.	AQFC480U-12S	AQFC480U-24S	AQFC480U-36S	AQFC480U-48S
Environment	Operating Temperature			
	-20°C...+70°C (with derating)			
	Storage Temperature			
	-25°C...+85°C			
	Temperature Coefficient			
	±0.03%/°C (0~50°C)			
Physical	Humidity			
	95% RH			
	MTBF			
	>100,000 h @ 25°C (MIL-HDBK-217F)			
Physical	Vibration			
	10~500Hz, 2G 10min./1cycle, 60min. each along X, Y, Z axes.			
Physical	Dimension (L x W x H)			
	7.0 x 4.2 x 1.78 Inches (177.8 x 106.5 x 45.0 mm) Tolerance ±0.5 mm			
Physical	Weight			
	780 g			
Safety	Agency Approvals			
		UL60950-1, CE(Surge:4KV)		
EMC	EMI (Conducted & Radiated Emission)			
	EN 55022 class B			
EMC	EMS (Noise Immunity)			
	EN 55024			

NOTE

1. Ripple & Noise are measured at 20MHz of bandwidth with 0.1uF & 47uF parallel capacitor.
2. Strongly recommend to conduct this test with DC Voltage. If customer wishes to test with AC Voltage, please disconnect all Y-Capacitors within Arch power supply.

BLOCK DIAGRAM

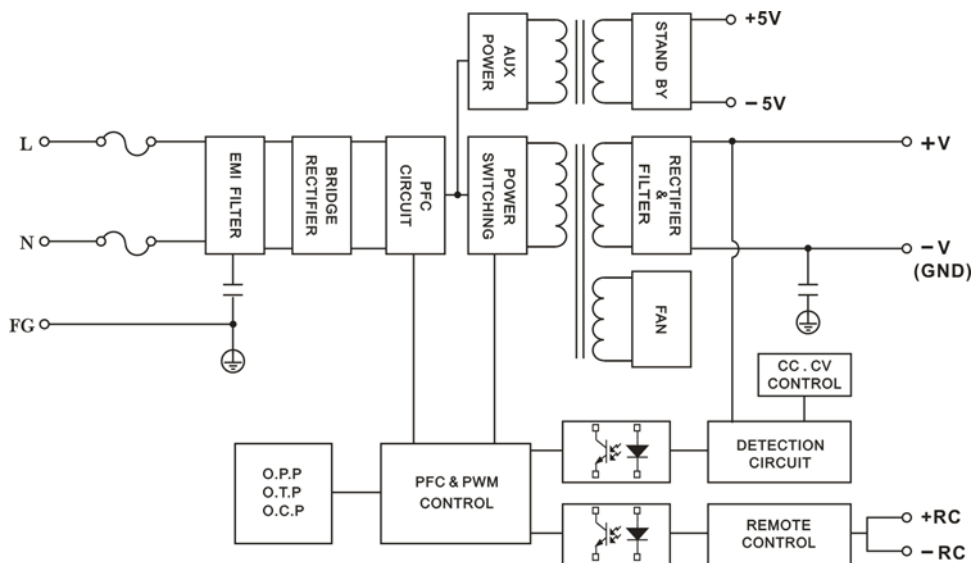

DERATING

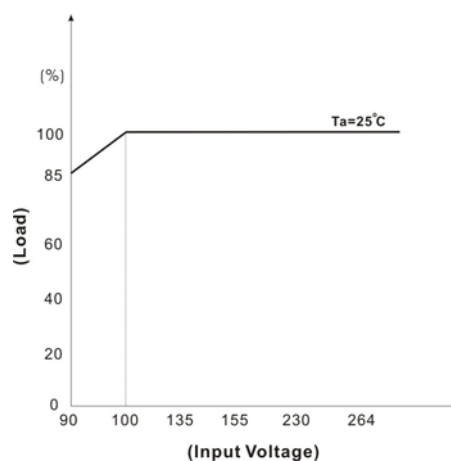
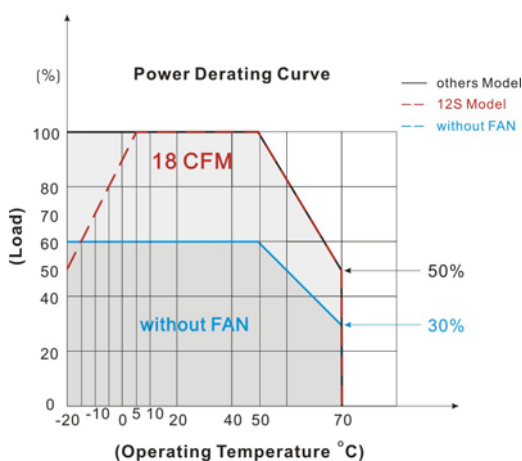

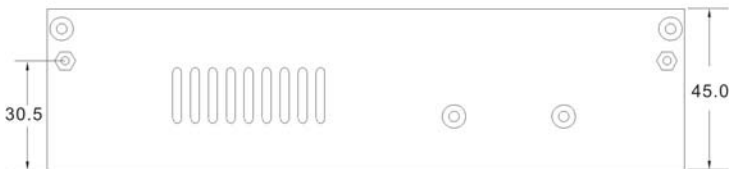
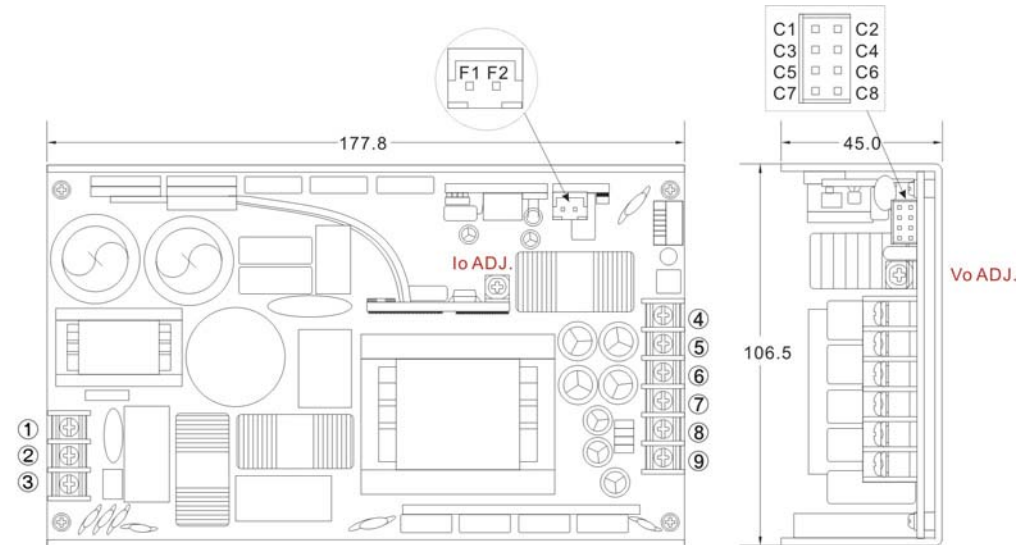
MECHANICAL DIMENSION
Standard

ASSEMBLY INSTRUCTIONS

*U Case T=2.0mm

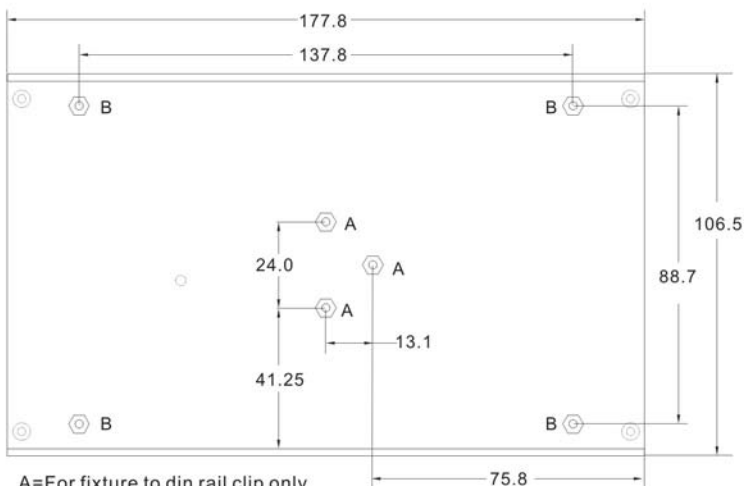
Customer is advised to screw into the threads no more than 2.0mm



A=For fixture to din rail clip only
 B=For fixture to pcb/chassis only
 A=M3x0.5P
 B=M3x0.5P

AC Input Terminal Pin

PIN#	Single
1	AC IN (N)
2	AC IN (L)
3	⏏

DC Output Terminal Pin

PIN#	Single
4~6	+DC OUT
7~9	-DC OUT

Connector Pin (CN4)

PIN#	Single
C1	NC
C2	NC
C3	+RC
C4	-RC
C5	NC
C6	NC
C7	+5V SB
C8	-5V SB

FAN Molex Pin

PIN#	Single
F1	-DC
F2	+DC

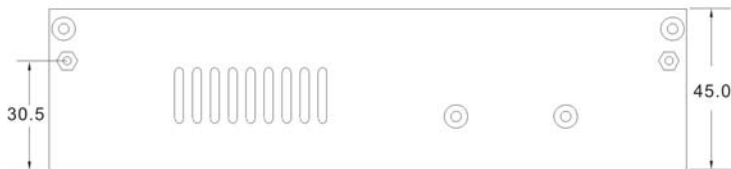
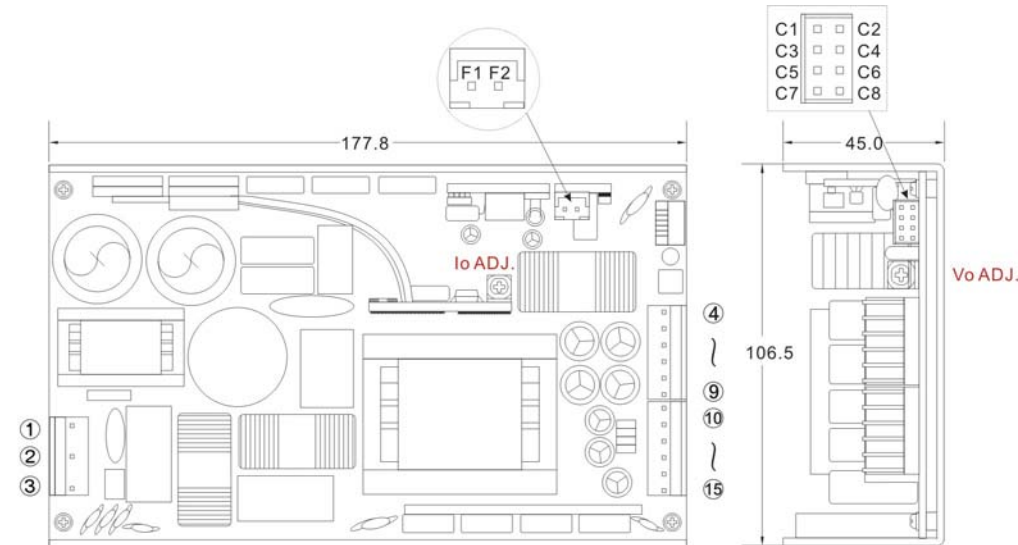
MECHANICAL DIMENSION
A Type

ASSEMBLY INSTRUCTIONS

*U Case T=2.0mm

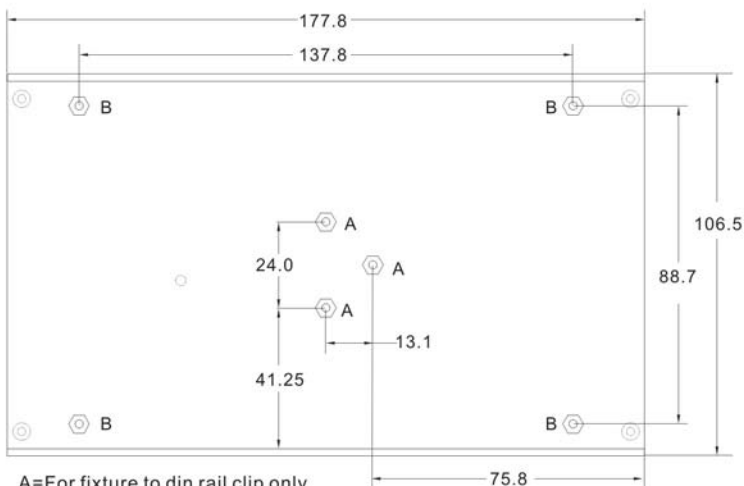
Customer is advised to screw into the threads no more than 2.0mm



A=For fixture to din rail clip only
 B=For fixture to pcb/chassis only
 A=M3x0.5P
 B=M3x0.5P

AC Input Terminal Pin

PIN#	Single
1	AC IN (N)
2	AC IN (L)
3	⏏

DC Output Terminal Pin

PIN#	Single
4~9	+DC OUT
10~15	-DC OUT

Connector Pin (CN4)

PIN#	Single
C1	NC
C2	NC
C3	+RC
C4	-RC
C5	NC
C6	NC
C7	+5V SB
C8	-5V SB

FAN Molex Pin

PIN#	Single
F1	-DC
F2	+DC

FUNCTION DESCRIPITON of CN4 :

Pin No.	Function	Description
C1	NC	
C2	NC	
C3	+RC	Turns the output on and off by electrical or dry contact between pin C4 (-RC), Short: Power OFF, Open: Power ON.
C4	-RC	Remote control ground.
C5	NC	
C6	NC	
C7	+5V SB	Stand by voltage output ground 4.5~5.5V, referenced to pin C8(-5V SB). The maximum load current is 0.6A.
C8	-5V SB	Stand by voltage output ground.

FUNCTION MANUAL :
Remote Control

It can be turned ON/OFF by using the "Remote Control" function.

Between RC+(pinC3) and RC-(pinC4)	Output Status
SW ON (Short)	OFF
SW OFF (Open)	ON

