

KEY FEATURES

- Switching Power Module for PCB Mountable
- Fully Encapsulated Plastic Case
- Universal Input Range 90-305VAC, 47-63 Hz
- Isolation Class II
- Maximum No-Load Watts < 0.3W
- CE, CB and UL Approval
- 3-Year Product Warranty



ELECTRICAL SPECIFICATIONS

All specifications valid at normal input voltage, full load and +25°C after warm-up time unless otherwise stated.

Model No. (Single Output)	AZC-3.3S	AZC-5S	AZC-9S	AZC-12S	AZC-15S	AZC-24S	
Max Output Wattage (W)	2W						
Input	Voltage						90-305 VAC or 120-430 VDC
	Frequency (Hz)						47-63 Hz
	Current (Full load)						75 mA max. (115 VAC) / 55 mA max. (230 VAC)
	Inrush Current (<2ms)						30 A max. (115 VAC) / 50 A max. (230 VAC)
	Leakage Current (<240 VAC)						0.25 mA max.
	External Fuse (mandatory)						3.15 A slow blow type
	External Varistor						14S561K
Output	Voltage (V.DC.)						3.3V 5V 9V 12V 15V 24V
	Voltage Accuracy						±6%
	Current (mA) max						600 400 222 167 133 83
	Line Regulation (LL-HL) (typ.)						±5%
	Load Regulation (10-100%) (typ.)						±6%
	Minimum Load						0%
	Maximum Capacitive Load						7000uF 4000uF 1200uF 500uF 350uF 110uF
	Ripple & Noise (Vp-p)						300mV
	Efficiency (at 115 VAC)						66% 70% 73% 73% 73% 75%
	Hold-up Time (at 230 VAC)						15 ms min.
Protection	Over Power Protection						Hiccup technique, auto-recovery
	Short Circuit Protection						Hiccup mode, indefinite (automatic recovery)
Isolation	Input-Output (V.AC)						3000V
Environment	Operating Temperature						-40°C...+80°C (with derating)
	Storage Temperature						-40°C...+85°C
	Temperature Coefficient						±0.02%/°C
	Humidity						95% RH
	MTBF						>450,000 h @ 25°C (MIL-HDBK-217F)
Physical	Dimension (L x W x H)						1.12 x 1.02 x 0.67 Inches (28.5 x 25.8 x 17.0 mm) Tolerance ±0.5 mm
	Case Material						Plastic resin (flammability to UL 94V-0)
	Weight						19.9 g
	Cooling Method						Free air convection
Safety	Agency Approvals						UL, cUL, CE, CB
EMC	EMI (Conducted & Radiated Emission)						EN 55022 class B
	EMS (Noise Immunity)						EN 55024

NOTE

1. Ripple & Noise are measured at 20MHz of bandwidth with 0.1uF & 47uF parallel capacitor.
2. Hold-up Time measured at 90% Vout.
3. It's necessary Varistor 14S561K at L / N input side in parallel.
4. It's necessary 10R / 15φ thermistor at L input side in series connection.
5. Please refer to our PDF file "AC-DC Application" on our website: www.archcorp.com.tw

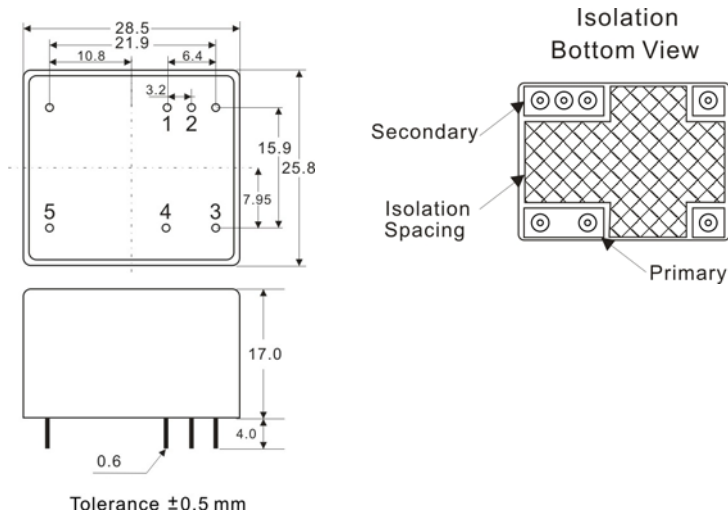
MECHANICAL DIMENSION (Top View)

PIN#	Single
1	+DC OUT
2	-DC OUT
3	AC IN (N)
4	AC IN (L)
5	NC

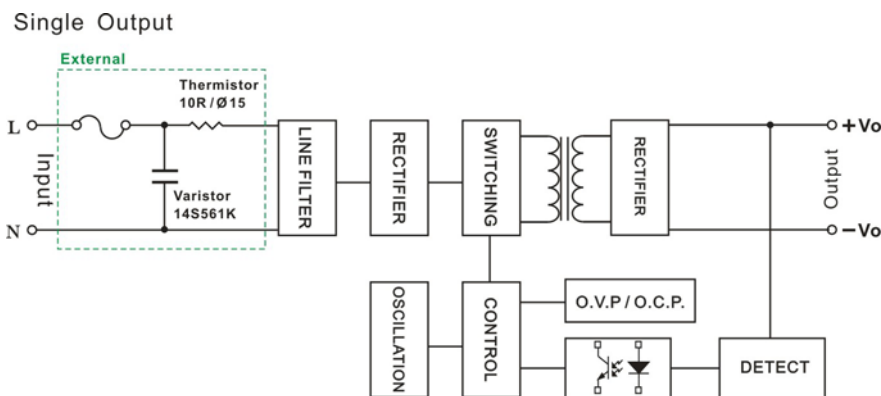
BLOCK DIAGRAM

DERATING
