



# BD35025

## 35W SINGLE DC/DC CONVERTER

10.5–18V<sub>IN</sub> 55V<sub>OUT</sub> (±27.5)

### Key Features

- Efficiency up to 82%
- 2:1 input voltage range
- Input under/overvoltage protection
- 3500Vdc input-to-output isolation
- Soft start
- Dual short circuit protection
- 500µA off state current
- Multiple converter synchronization
- Adjustable outputs
- 170kHz switching frequency
- Thermal protection
- Dual isolated outputs
- Six-sided shielding



### Functional Description

The BD35025 is a 35W continuous power converter that accepts an input voltage from 10.5–18V<sub>IN</sub> and provides a constant output of 55V<sub>OUT</sub>@0.64A (±27.5V<sub>OUT</sub>). The converter is designed and tested for 1500Vdc input-to-output isolation voltage.

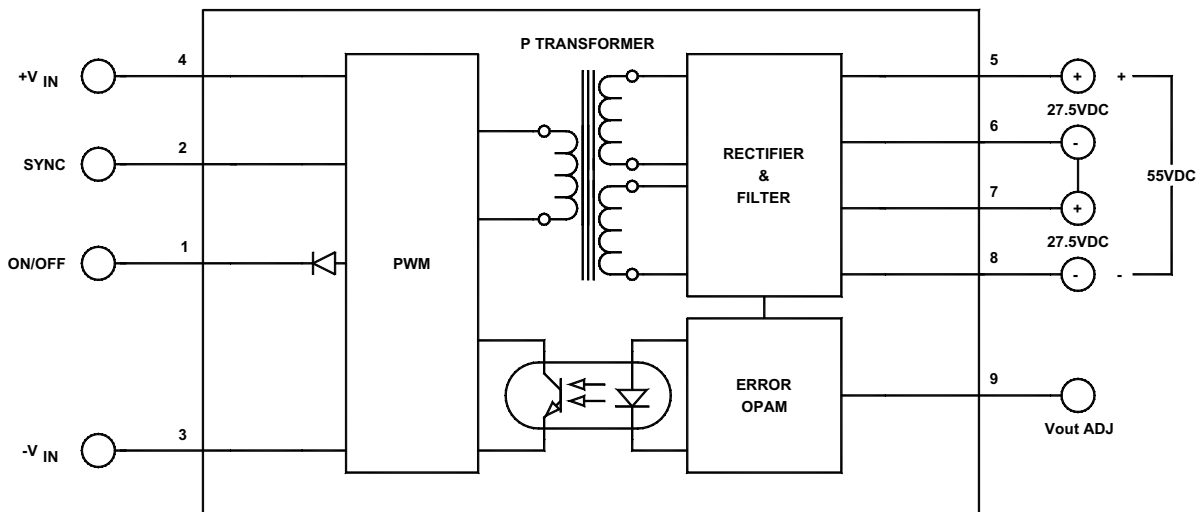

Typical Block Diagram

## Electrical Specifications

### INPUT SPECIFICATIONS

Unless otherwise specified, all parameters are given under typical +25°C with nominal input voltage and under full output load conditions.

PARAMETER	CONDITION / NOTE	MIN	TYP	MAX	UNIT
Input Voltage Range		10.5	12	18	Vdc
Input Startup Voltage		10.5			Vdc
Input Overvoltage Protection		18	20		Vdc
Input Filter	Pi ( $\pi$ )				
Reverse Polarity 	External series-blocking diode				
Reflected Ripple	$I_o = FL, C_1 = 1,000\mu F$		50		mV <sub>PP</sub>
No Load Input Current			40		mA
Full Load Input Current			3557		mA
Input Surge Current (20 $\mu$ S Spike)				10	A
Short Circuit Current Limit	Input side, $1.5 \cdot I_{IN}$ at full load				
Off State Current			500		$\mu$ A
Remote ON/OFF Control					
Supply ON	Pin 1 Open (Open circuit voltage: 13V max.)				
Supply OFF		0		0.8	Vdc
Logic Input Reference	-Input for ON/OFF and SYNC				
Logic Compatibility for Reference	TTL Open Collector or CMOS Open Drain				
Sync, High	See External Synchronization, Figure 4	2		6	Vdc
Sync, Low	See External Synchronization, Figure 4	0		0.8	Vdc

### OUTPUT SPECIFICATIONS

PARAMETER	CONDITION / NOTE	MIN	TYP	MAX	UNIT
Output Voltage	Measured between Pin 5 (+) and Pin 8 (-)		55		Vdc
Output Voltage Accuracy			$\pm 1$	$\pm 2$	%
Output Current	Continuous		640		mA
Ripple & Noise			1	2	%V <sub>PP</sub> of V <sub>OUT</sub>
Line Regulation, Single and Dual			$\pm 0.5$	$\pm 1$	%
Load Regulation, Dual	With balanced loads		$\pm 1$	$\pm 2$	%
Temperature Coefficient @ FL			0.02		%/°C
Transient Response Time	50% FL to FL to 50% FL		200	250	$\mu$ S
Short Circuit Protection	By input current limiting				
Output Adjust Range		$\pm 5$		$\pm 10$	%

### GENERAL SPECIFICATIONS

PARAMETER	CONDITION / NOTE	MIN	TYP	MAX	UNIT
Efficiency			82		%
Isolation Voltage (1 min.), Input to Output			1500		Vdc
Isolation Resistance			$10^9$		$\Omega$
Isolation Capacitance			2700		pF
Switching Frequency			170		kHz
Turn On Delay	See Figure 6		7	10	mS
Soft Start Time	See Figure 6		7	15	mS

## ENVIRONMENTAL SPECIFICATIONS

PARAMETER	CONDITION / NOTE	MIN	TYP	MAX	UNIT
Operating Temperature Range (Ambient)*	See Figure 2	-40		+71	°C
Storage Temperature Range		-55		+125	°C
Thermal Resistance	°C per watt internally dissipated		7	10	°C/W <sub>DISS</sub>
Maximum Operating Case Temperature				110	°C
Derating	See Figure 2				
Cooling	Free-air convection				
EMI/RFI	Six-sided continuous shielded metal case				
MTBF	per MIL-HNBK-217F (Ground benign, +25°C)		1.1×10 <sup>6</sup>		hours
Humidity	Up to 95% non-condensing				
Thermal Shutdown	Case Temperature		110	115	°C
Thermal Hysteresis		2	5		°C

\* See footnotes 2, 3, 4 and 5

## PHYSICAL CHARACTERISTICS

PARAMETER	CONDITION / NOTE	MIN	TYP	MAX	UNIT
Dimensions (L×W×H)	2.00×2.00×0.50 in. (50.80×50.80×12.70mm)				
Weight	2.43 oz. (69g)				
Case Material	Coated metal				
Shielding Connection, 12V <sub>IN</sub>	-V <sub>IN</sub> (Pin 3)				

<sup>1</sup> ⚠ WARNING - Usage of input fuse with adequate ratings is essential to avoid possible hazard and damage of the unit. A suppressor diode with adequate ratings is intended to be connected in series to the supply for reverse polarity protection.

<sup>2</sup> Contact factory for -55° to +85°C operating temperature range.

<sup>3</sup> The maximum input current at any given input range measured at minimum input voltage is given as 1.6\*I<sub>NOMINAL</sub>. Nominal input current is the typical value measured at the input of the converter under full-load room temperature and nominal input voltage (12, 24, 48, and 120Vdc).

<sup>4</sup> Adequate insulation is to be provided to the converters at the end usage as per applicable requirements.

<sup>5</sup> Temperature rise on the case of the converters is to be considered during the end usage as per applicable requirements.

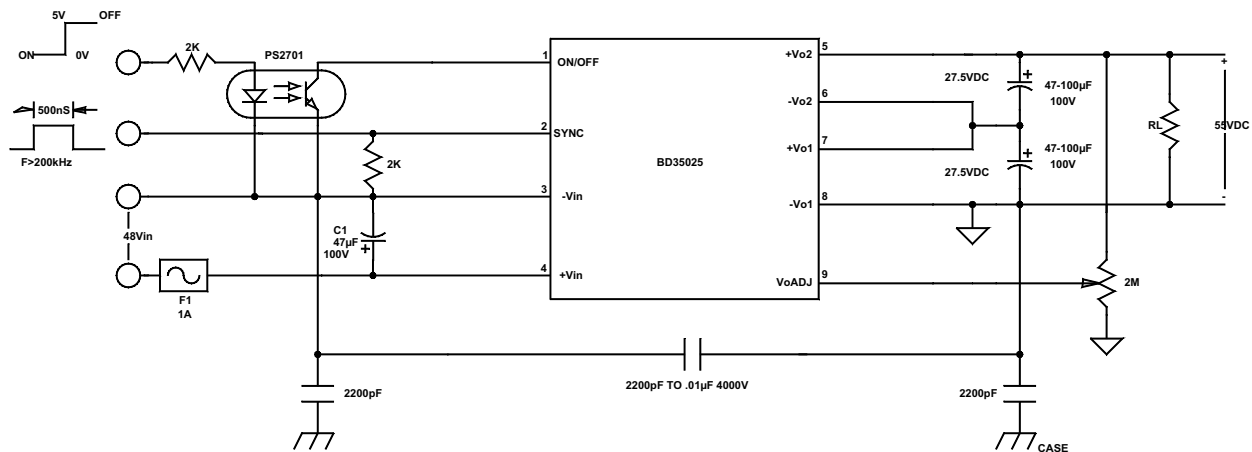

FIGURE 1. Typical connection diagram

NOTE: For bipolar operation  $\pm 27.5V$ , Pins 6 ( $-V_{O2}$ ) and 7 ( $+V_{O1}$ ) are connected to the output common and Pin 9 ( $V_O$  ADJ) is referenced to Pin 8 ( $-V_O$ ).

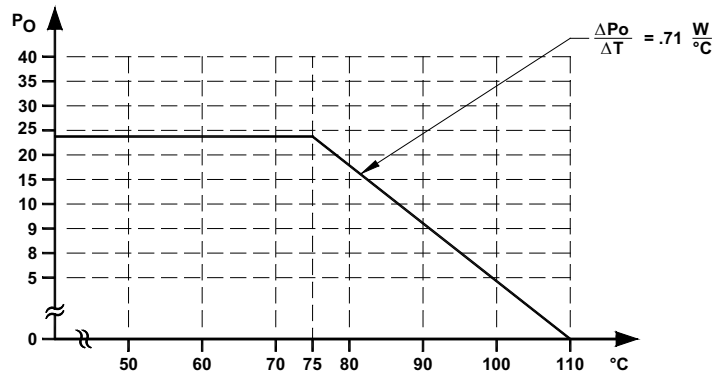

FIGURE 2. Derating with free air convection

**EXTERNAL TRIMMING OF OUTPUT VOLTAGES (SINGLE AND DUAL ONLY)**

To trim the output voltage DOWN, connect a 5% 1/4W 1.5MΩ resistor (DO NOT GO BELOW 1MΩ) between the +V<sub>O1</sub> (Pin 7) output and trim pin of the converter. To trim the output voltage UP, connect a 5% 1/4W resistor between the -V<sub>O1</sub> (Pin 8) output and trim pins of the converter. For UP/DOWN trimming capability, connect a 2MΩ potentiometer between the + and - output pins, with the wiper arm connected to the trim pin.

converter output pins or the load. However, if connected at the load, the resistance of the runs becomes part of the feedback network which improves load regulation. If the load is some distance from the converter, the use of #20 gauge wire is recommended to avoid excessive voltage drop due to the resistance of the circuit paths.

See our application notes:

DC-001: Testing Transient Response in DC/DC Converters

DC-004: Thermal Consideration for DC/DC Converters

The trim resistors/potentiometer can be connected at the

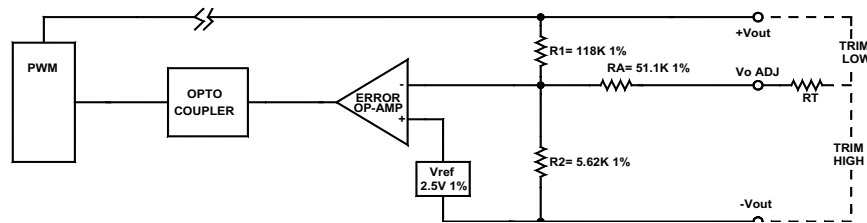

FIGURE 3. Output control circuit

To trim V<sub>O</sub> higher to V<sub>O</sub>' , where V<sub>O</sub> is the actual measured value:

$$RT = \frac{R1 \cdot V_{REF}}{V_o' - V_o} \quad \text{For the above given values: } RT = \frac{500,000}{V_o' - V_o} - 51.5k$$

To trim V<sub>O</sub> lower to V<sub>O</sub>'' , where V<sub>O</sub> is the actual measured value:

$$RT = \left[ \left( \frac{R_1 \cdot V_{REF}}{R_2(V_o - V_o'')} - R1 \right) 51.5k \right]$$

### EXTERNAL SYNCHRONIZATION

A TTL signal applied at the SYNC pin of the converter will synchronize the switching frequency of the converter to that of the TTL input signal. The external (TTL) frequency must be equal or higher than the converter's frequency. At the positive-going edge of the applied pulse, the internal power-switching transistor turns off and the PWM discharges its timing capacitor. At the negative-going edge, the PWM resumes normal operation. The minimum positive pulse width of the TTL signal must be 300nS minimum and its frequency

between 150kHz and 180kHz. NOTE: Higher frequencies will reduce the efficiency of the converter and wide TTL pulses will force the PWM to follow the external TTL width modulation, which may effect regulation. A high TTL signal at the SYNC pin of the converter will turn the converter off. An internal pull-down resistor will keep this pin low when it is not used. A pulse differentiator (see Figure 5) can be used to shape a square wave sync signal as shown in Figure 4.

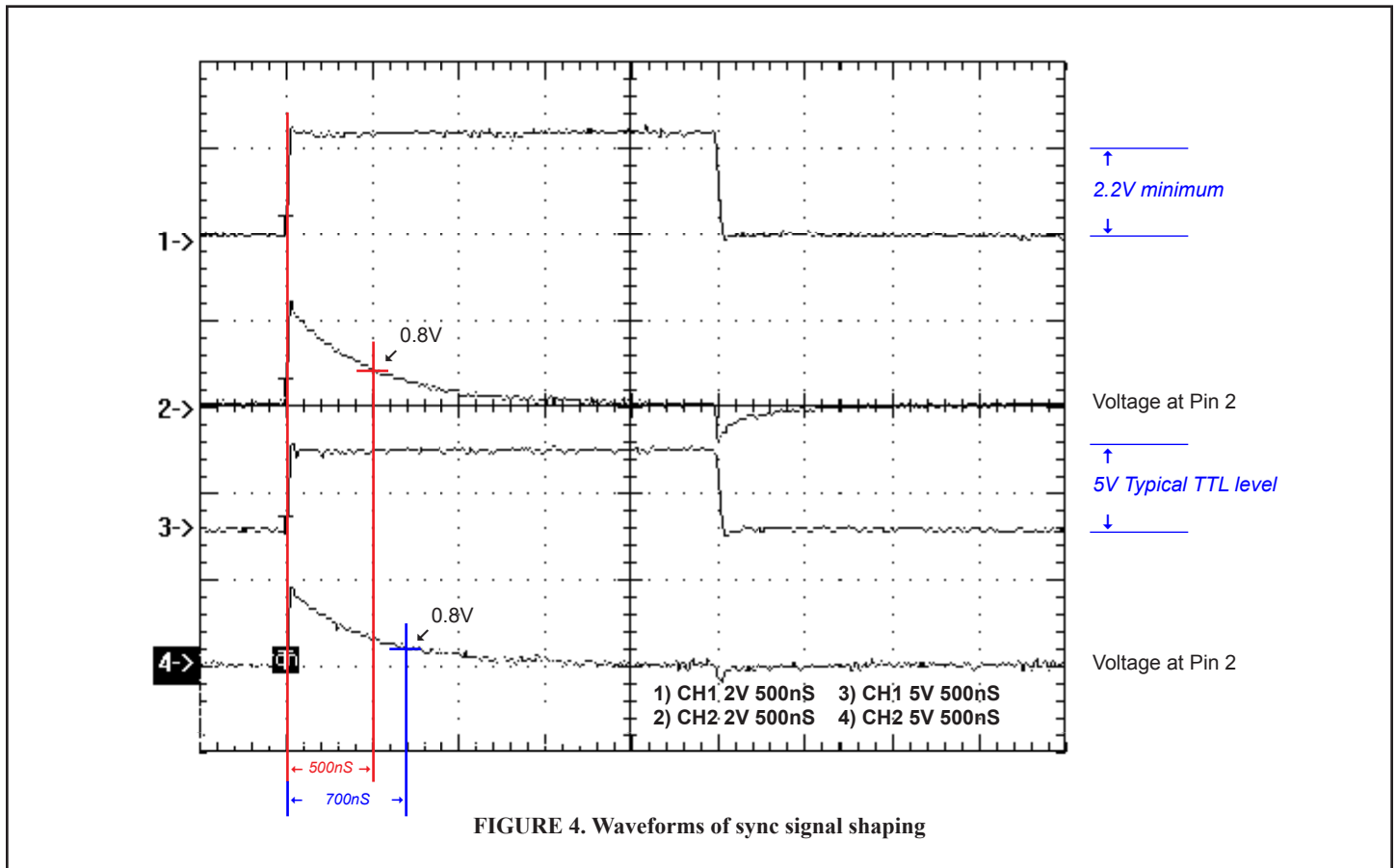

### SYNC SIGNAL SHAPING

As described in External Synchronization, the PWM of the converter requires a TTL signal of 0.8 to 2Vdc minimum amplitude and minimum duration of 300nS. When such a signal is not available (through one shot multivibrator or other pulse-shaping circuits) a C-R differentiator, such as the one in Figure 4, can be used to shape a square wave TTL signal. As is shown by the oscillogram in Figure

4, the positive edge of the sync pulse must be 2V minimum and the decaying exponential must reach the low 0.8Vdc in 300nS minimum from the positive edge. The parallel diode with the resistor is a small signal switching diode or a Schottky signal diode with 0.3 to 0.5V forward drop, it is used to clamp the voltage at pin 2@-0.5Vdc.

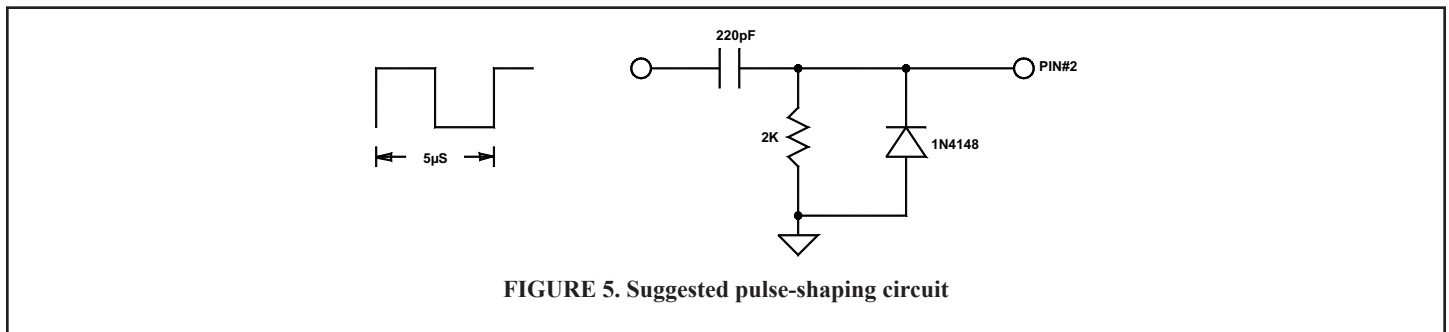

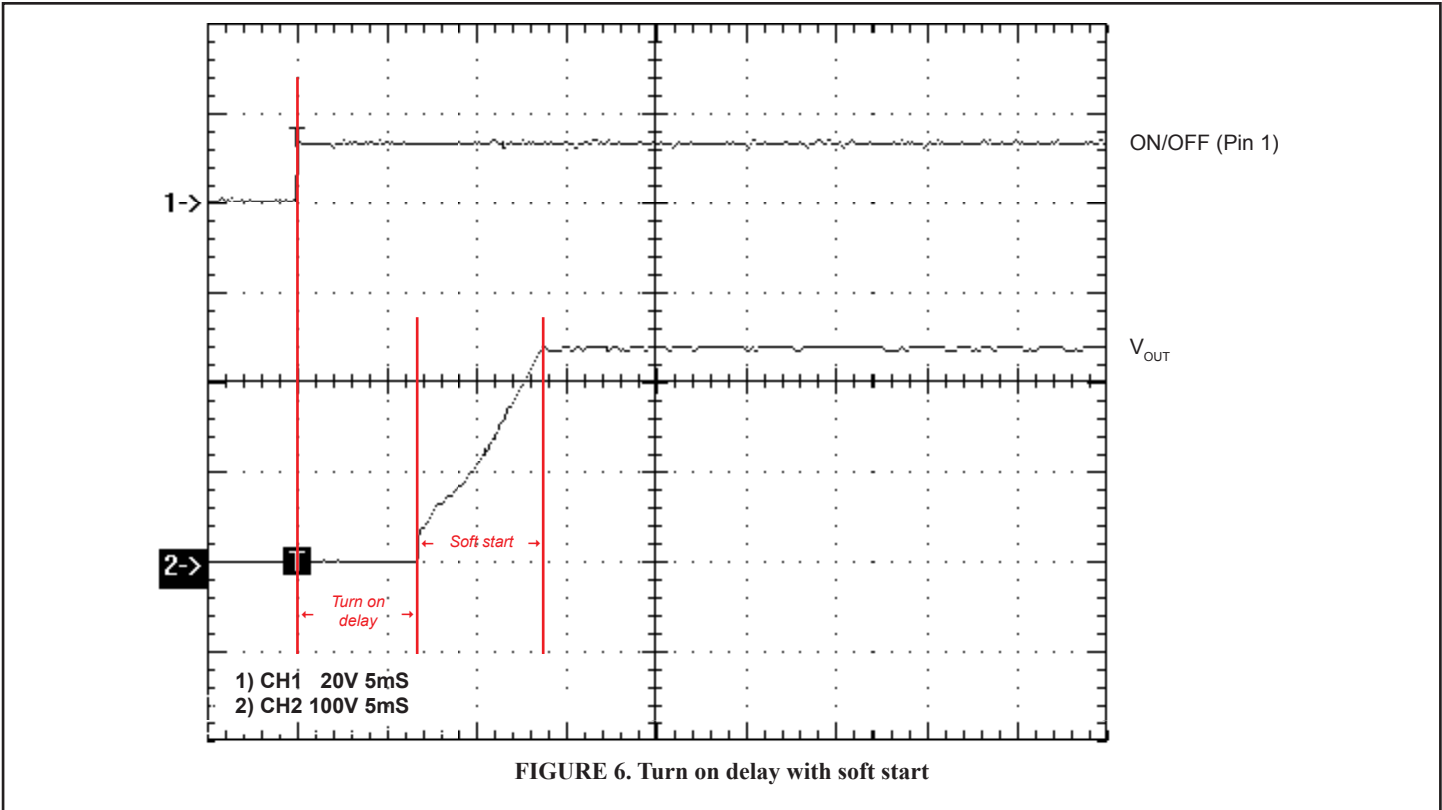

**SHORT CIRCUIT PROTECTION**

The converter has a dual short circuit protection feature. At the input side of the converter, two short circuit current comparators are used to monitor the input current of the converter. They are biased at different voltage levels; the lower threshold (LTH) comparator provides the power limiting function of the converter. Under normal operating conditions, the LTH comparator limits the output power of the converter when the maximum output power is exceeded.

When a hard short is applied across the output of the converter and the input current exceeds the set threshold of the second

comparator, the converter goes into shutdown mode, the overcurrent latch is set and the converter is turned off. The converter will turn on again when its input voltage is recycled (OFF-ON) or if the ON/OFF pin is used to turn the converter on and off. The time required for the ON/OFF pin to be held low is between 100mS and 800mS.

